

## ■ Description

FA3630V is a DC-DC converter controller. This IC can directly drive a Nch/Pch-MOSFET. This IC is suitable to reduce converter size because it has many functions in a small package TSSOP.

## ■ Features

- Low input voltage: 2.5V to 6.5V
- 2-channels PWM control: Rail-to-rail output  
Output impedance of output stage =  $3.5\Omega$  (typ.)  
Nch-MOSFET driving (Ch1)  
Nch/Pch-MOSFET driving (Ch2)(selected by SEL pin)
- Low power consumption: 0.7mA (typ.)
- ON/OFF control: Standby current =  $0.1\mu\text{A}$  (typ.)
- $\pm 2\%$  high accuracy reference voltage
- Adjustable soft start time and maximum duty cycle
- Adjustable built-in timer latch for short circuit protection
- Wide range of operation frequency: 100kHz to 1MHz
- Package: TSSOP-16 (Thin and small)

## ■ Applications

- Power supply for general equipment

## ■ Dimensions, mm

### ● TSSOP-16

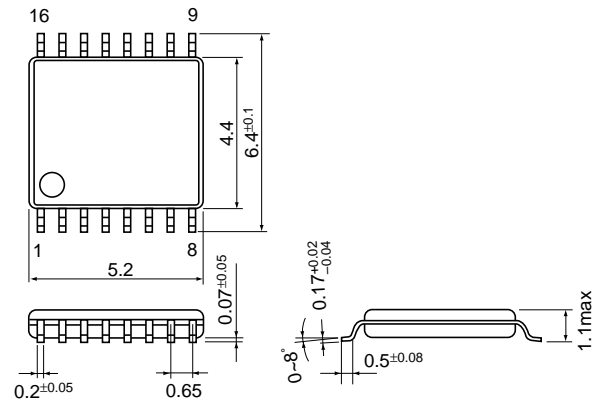

## ■ Block diagram

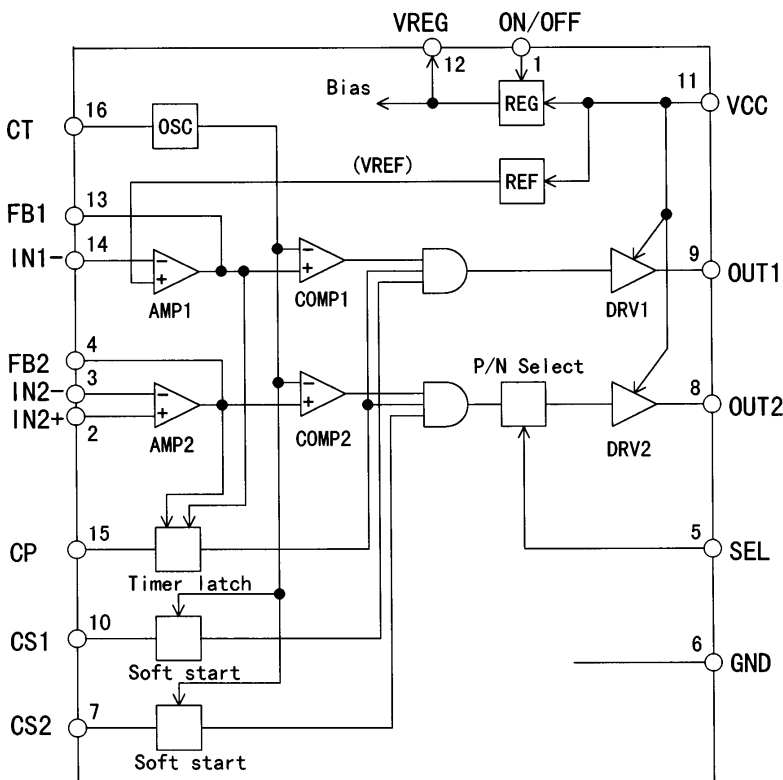

Pin No.	Pin symbol	Description
1	ON/OFF	ON/OFF function
2	IN2+	Ch. 2 non-inverting input to error amplifier
3	IN2-	Ch.2 inverting input to error amplifier
4	FB2	Ch. 2 output of error amplifier
5	SEL	Selection of type of MOSFET driven
6	GND	Ground
7	CS2	Soft start for Ch. 2
8	OUT2	Ch. 2 output (for Nch or Pch-MOSFET)
9	OUT1	Ch.1 outout (for Nch-MOSFET)
10	CS1	Soft start for Ch.1
11	VCC	Power supply
12	VREG	Regulated voltage output
13	FB1	Ch.1 output of error amplifier
14	IN1-	Ch.1 inverting input to error amplifier
15	CP	Timing capacitor for timer latch delay
16	CT	Oscillator timing capacitor

### ■ Absolute maximum ratings

Item	Symbol	Rating	Unit
Power supply voltage	V <sub>CC</sub>	6.5	V
Source peak current of OUT1/2	I <sub>OUT+</sub>	-500	mA
Sink peak current of OUT1/2	I <sub>OUT-</sub>	500	mA
Input voltage for logic input	V <sub>LOG</sub>	-0.3 to +6.5	V
Output current of VREG	I <sub>REGMAX</sub>	-10	mA
Total power dissipation*	P <sub>d</sub>	300	mW
Junction temperature	T <sub>J</sub>	125	°C
Ambient temperature	T <sub>OP</sub>	-20 to +85	°C
Storage temperature	T <sub>stg</sub>	-40 to +125	°C

\* Ta ≤ 25°C

### ■ Recommended operating conditions

Item	Symbol	Min.	Max.	Unit
Power supply voltage	V <sub>CC</sub>	2.5	5.5	V
Input voltage for logic input	V <sub>LOG</sub>	0	5.5	V
Oscillation frequency	f <sub>osc</sub>	100	1000	kHz

### ■ Electrical characteristics (V<sub>CC</sub>=3.3V, Ta=25°C, C<sub>T</sub>=100pF)

#### Regulated voltage section for internal control blocks

Item	Symbol	Test condition	Min.	Typ.	Max.	Unit
Regulated voltage	V <sub>REG</sub>	I <sub>REG</sub> =no load	2.156	2.200	2.244	V
Variation with output current	V <sub>RGOUT</sub>	V <sub>REG</sub> =0 to 5mV			5	mV
Variation with supply voltage	V <sub>RGLIN</sub>	V <sub>CC</sub> =2.5 to 5.5V			8	mV
Variation with temperature	V <sub>RGTa</sub>	Ta=-20 to +25°C		±0.5		%
		Ta=+25 to +85°C		±0.5		%

#### Reference voltage section

Item	Symbol	Test condition	Min.	Typ.	Max.	Unit
Reference voltage	V <sub>REF</sub>		0.98	1.00	1.02	V
Variation with supply voltage	V <sub>RGLIN</sub>	V <sub>CC</sub> =2.5 to 5.5V		1	5	mV
Variation with temperature	V <sub>RGTa</sub>	Ta=-20 to +25°C		±0.5		%
		Ta=+25 to +85°C		±0.5		%

#### Oscillator section

Item	Symbol	Test condition	Min.	Typ.	Max.	Unit
Oscillation frequency	f <sub>osc</sub>	C <sub>T</sub> =100pF	437	485	533	kHz
High level voltage	V <sub>OSCH</sub>	C <sub>T</sub> =100pF		1.39		V
Low level voltage	V <sub>OSCL</sub>	C <sub>T</sub> =100pF		0.77		V
Variation with supply voltage	f <sub>dV</sub>	V <sub>CC</sub> =2.5 to 5.5V		±1	±5	%
Variation with temperature	f <sub>dT</sub>	Ta=-20 to +25°C		±5		%
		Ta=+25 to +85°C		±5		%

#### Error amplifier section

Item	Symbol	Test condition	Min.	Typ.	Max.	Unit
Input offset voltage	V <sub>IOF</sub>			3	10	mV
Common mode input voltage	V <sub>ICOM</sub>		0.2		1.5	V
DC open loop gain	A <sub>VOL</sub>		70	75		dB
Unity gain band width	f <sub>T</sub>			1.6		MHz
Output sink current	I <sub>FBL</sub>	V <sub>FB</sub> =0.5V	2.0	2.5	3.0	mA
Output source current	I <sub>FBH</sub>	V <sub>FB</sub> =V <sub>REG</sub> -0.5V	-160	-125	-90	μA

**ON/OFF logic input signal section**

Item	Symbol	Test condition	Min.	Typ.	Max.	Unit
Input range for ON mode	VONH	V <sub>CC</sub> =2.5V to 5.5V	2.0			V
Input range for OFF mode	VONL	V <sub>CC</sub> =2.5V to 5.5V			0.5	V

**SEL logic input signal section**

Item	Symbol	Test condition	Min.	Typ.	Max.	Unit
Input range for driving Nch-MOSFET	VSELH		V <sub>CC</sub> -0.5			V
Input range for driving Pch-MOSFET	VSELL				0.5	V

**Timer latch protection section**

Item	Symbol	Test condition	Min.	Typ.	Max.	Unit
Threshold voltage of CP	V <sub>CP</sub> TH		1.55	1.70	1.85	V
Charge current of CP	I <sub>CP</sub>	V <sub>CP</sub> =V <sub>REG</sub> -0.5V	-2.5	-2.1	-1.7	μA
Threshold voltage of FB1/FB2	V <sub>FB</sub> TL		1.56	1.73	1.90	V

**Soft-start section**

Item	Symbol	Test condition	Min.	Typ.	Max.	Unit
Threshold voltage of CS1/2	V <sub>CS</sub> 0	Duty cycle=0%	0.74	0.79	0.84	V
Threshold voltage of CS1/2	V <sub>CS</sub> 100	Duty cycle=100%	1.29	1.34	1.39	V

**Output section**

Item	Symbol	Test condition	Min.	Typ.	Max.	Unit
ON resistance	OUT1 ( High / Low ) OUT2 ( High / Low )	I <sub>OUT</sub> =±100mA V <sub>CC</sub> =3.3V		3.5	7	Ω
				3.5	7	Ω
Rise time	OUT1 OUT2	C <sub>LOAD</sub> =1000pF V <sub>CC</sub> =3.3V		25	35	ns
				25	35	ns
Fall time	OUT1 OUT2	C <sub>LOAD</sub> =1000pF V <sub>CC</sub> =3.3V		25	35	ns
				25	35	ns

**Overall device**

Item	Symbol	Test condition	Min.	Typ.	Max.	Unit
Standby current	I <sub>CC0</sub>	ON/OFF=GND		0.1	5	μA
Operating average current	I <sub>CC</sub>	OUT1, OUT2: Open Output duty=100%		0.7	1	mA
	(Reference value)	OUT1, OUT2: Open IN- and FB: Shorted		1.5		mA

■ Characteristic curves (Ta=25°C)

Supply current (I<sub>CC</sub>) vs. supply voltage (V<sub>CC</sub>)

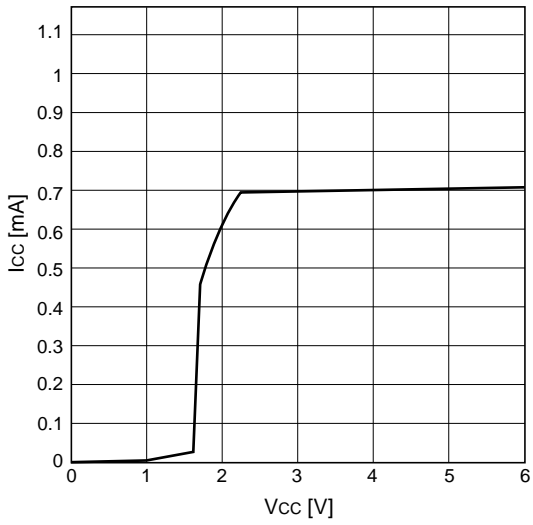

Oscillation frequency (f<sub>osc</sub>) vs. timing capacitor (C<sub>T</sub>)

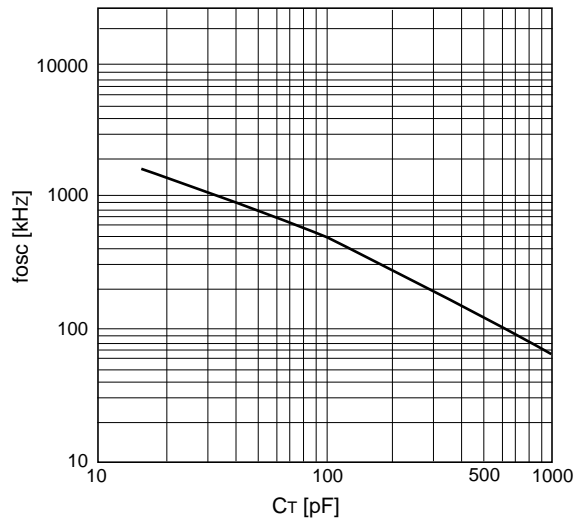

Output duty cycle vs. FB terminal voltage (V<sub>FB</sub>)

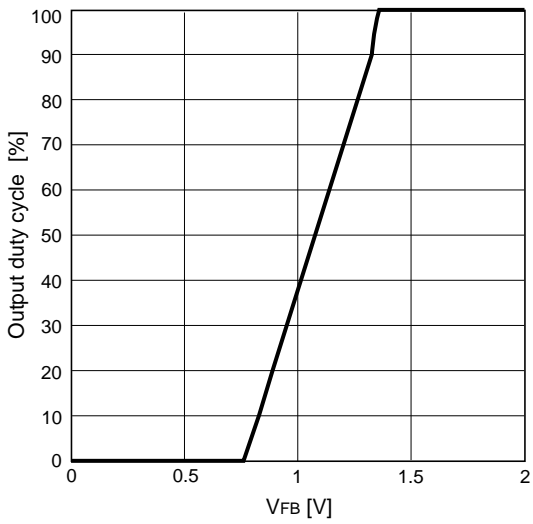

Output duty cycle vs. CS terminal voltage (V<sub>CS</sub>)

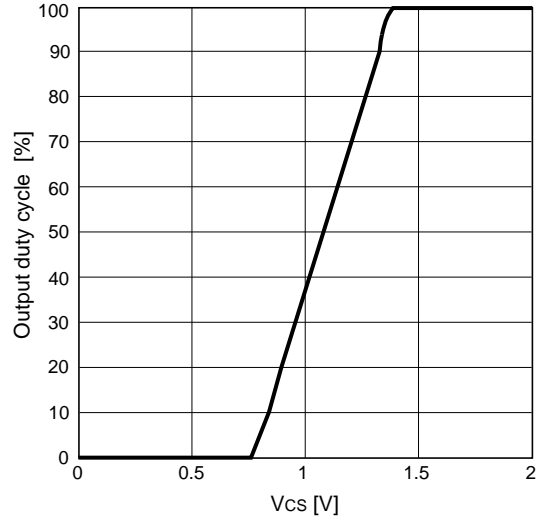

Oscillation frequency (f<sub>osc</sub>) vs. ambient temperature (T<sub>a</sub>)

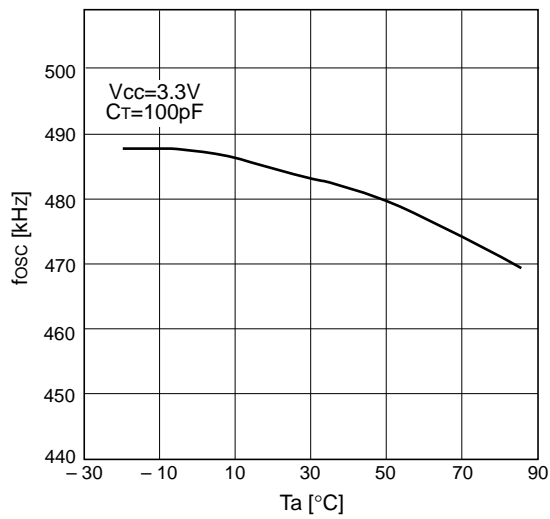

Reference voltage (V<sub>REF</sub>) vs. ambient temperature (T<sub>a</sub>)

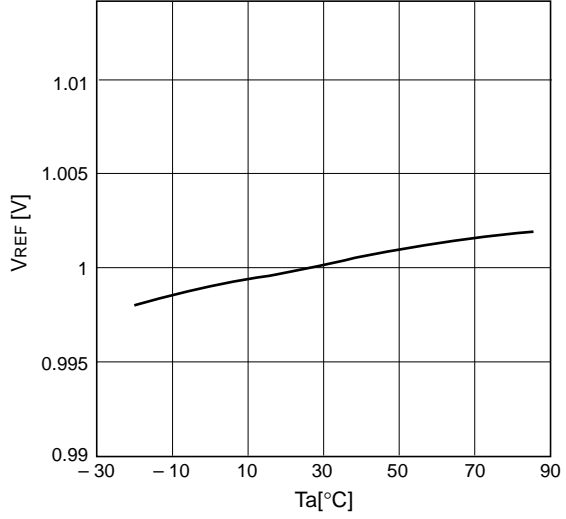

L-level output voltage (VOL1) vs. output sink current (ISINK1)

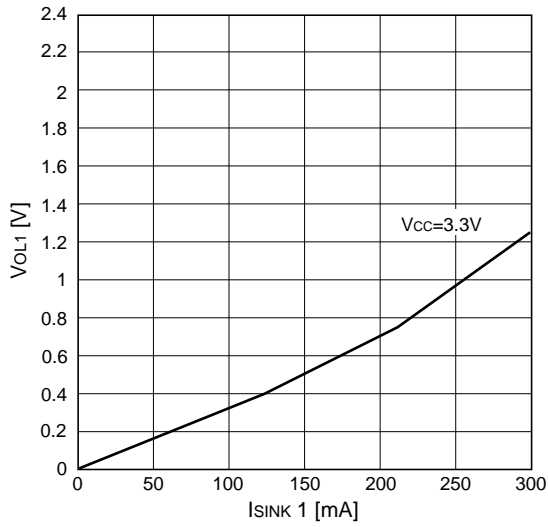

H-level output voltage (VOH1) vs. output source current (ISOURCE1)

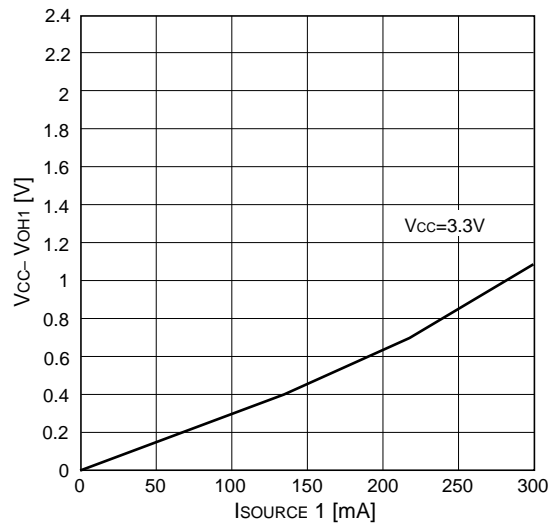

L-level output voltage (VOL2) vs. output sink current (ISINK2)

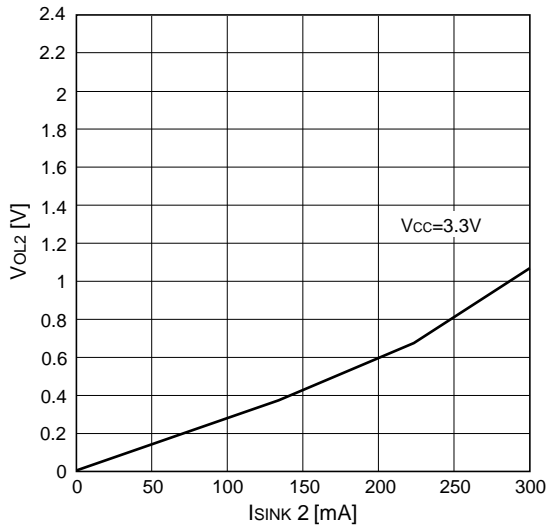

H-level output voltage (VOH2) vs. output source current (ISOURCE2)

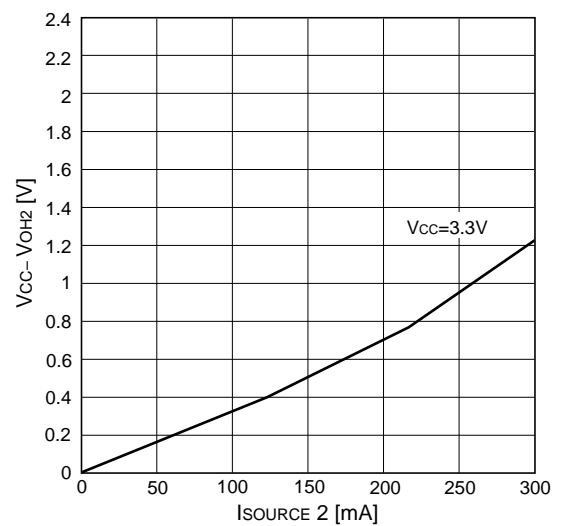

Error amplifier voltage gain (Av) / phase (θ) vs. frequency (f)

Condition: Open loop

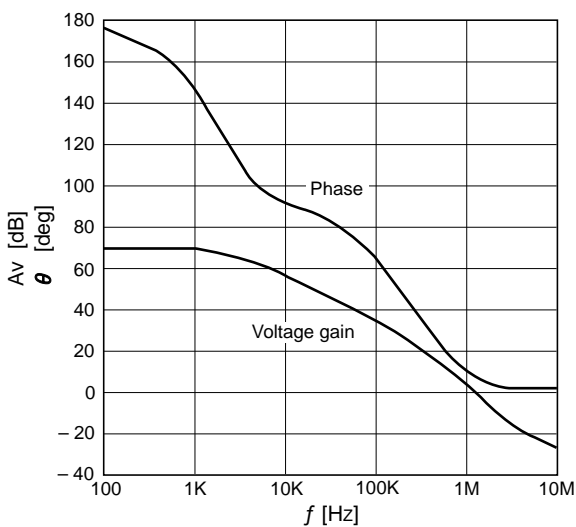

■ Application circuit

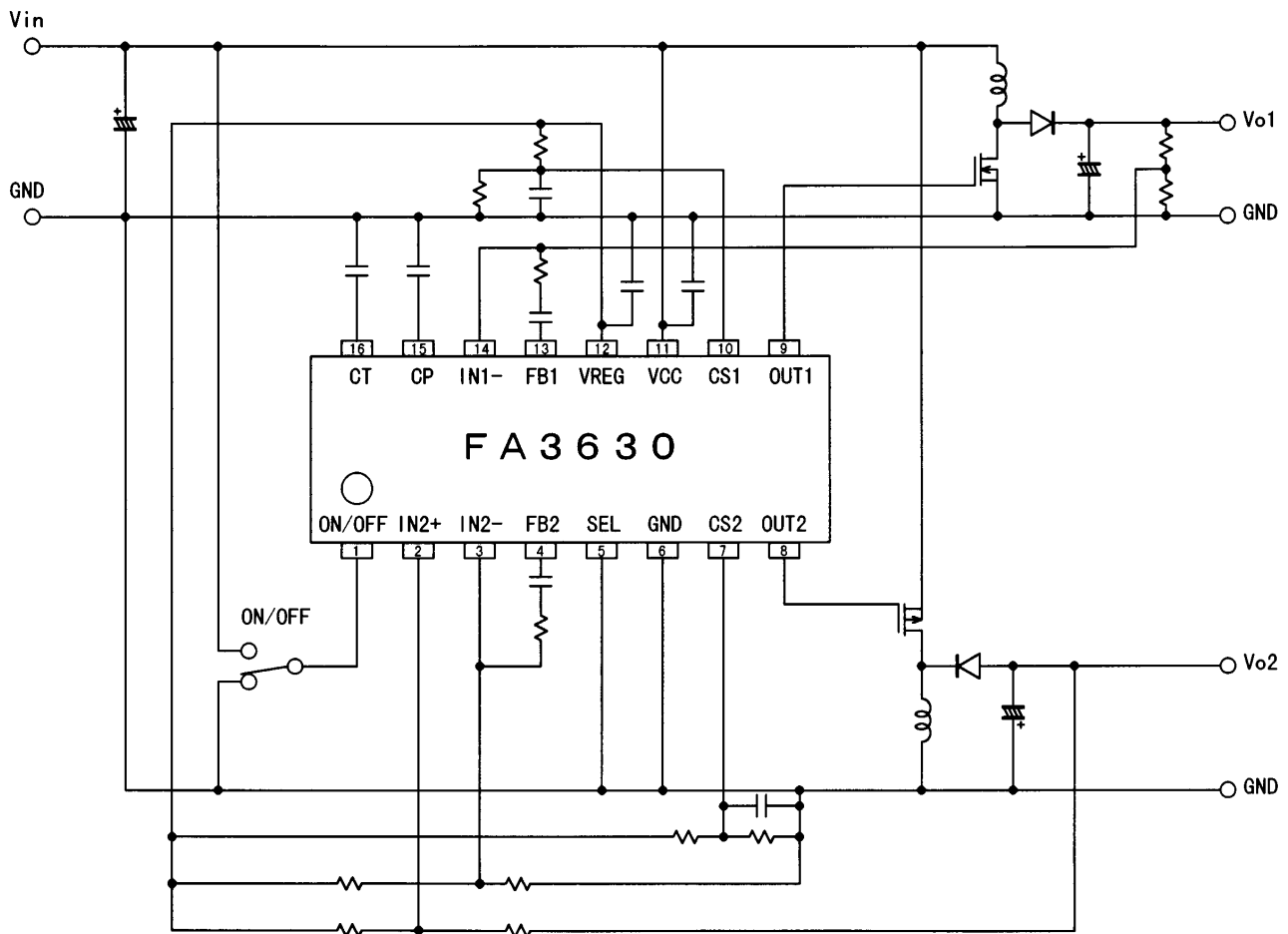

Parts tolerances characteristics are not defined in the circuit design sample shown above. When designing an actual circuit for a product, you must determine parts tolerances and characteristics for safe and economical operation.